

We optimize your events

Anycase Co.Ltd
EVENTS START HERE

Portable Plywood Flooring

Shopping Mall Booth Flooring

Exhibition expo Booth

Company Events

Conference

Weddings Venues

Fashion Show / T-Walk way





ACS portable plywood flooring suitable for temporary mall booth and store promotion.
-Quick renovation, fast dismantle.
-No need professional construction application and certification required.

Shopping Mall / Retail Store
Quick Promotion Renovation

Wedding Dancing Area

Remodeling and redefining wedding designs.

Glossy white surface shiny assemble freely.
More possibilities and profit is waiting for you.



Events / Car Show

Strong Loading capacity support 800kg/square meter.
Weeks events indoor & outdoor

The leader plywood flooring manufacturer since 2010, choose the best wood material from southern China. Our Black&White dance floor is made from plywood+Wood grain(1mm). Classic 'Checker Board' effect or gloss effect are available. The high gloss finish means that any lighting is reflected by the dance floor surface, creating a stunning look. When you want to create a wonderful party with lower budget, this is an ideal choice.

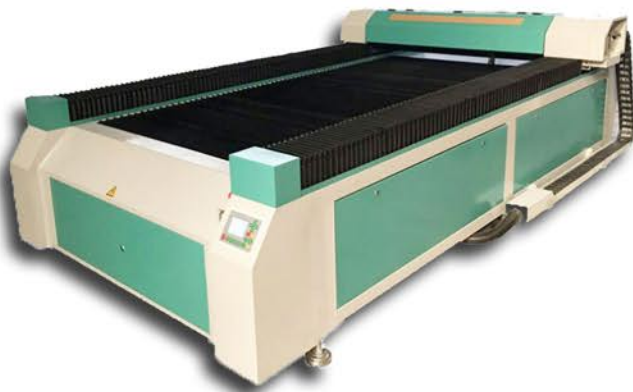

Professional Machine

The lathe is founded by industrial pipe welding, box-type structure to ensure the high stability.

The professional mechanical design, scientific structure and generous appearance. High quality driver motor, spindle motor, cables, inverters, etc. Professional CNC control system, can compatible with many kinds CAM software, such as

TYPE3/ARTCAM/UG/PRO-E/MASTERCAM



Excellent Quality Plywood



- 1.2mm Vinyl Layer
(Gloss / Matte / Wood grain / Acrylic / Glass)
- 15.8mm Laminate plywood
- 1mm Black Vinyl Sealed Layer

Skilled painting craftsmanship

Aluminum trim available in silver/white/
black/ gold.

Good craftsmanship durable & scratch resisting.

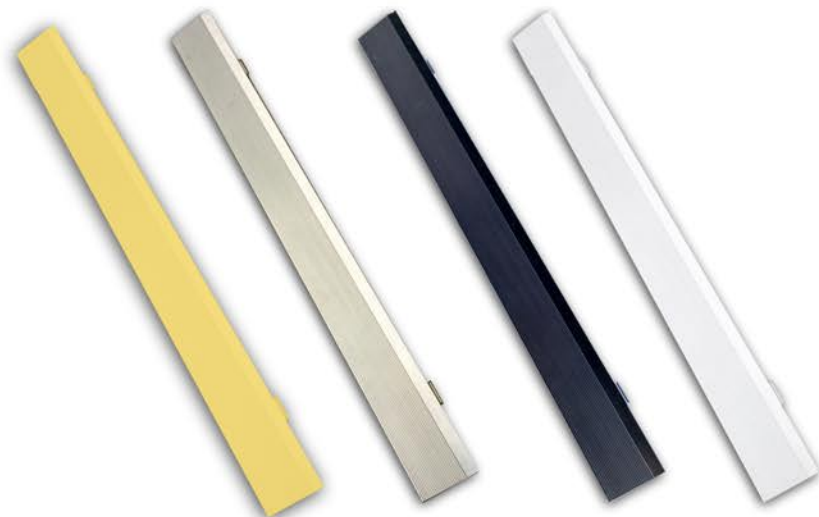

Original Design Locking System

Faster assemble

Stronger hook connect



① Tilt lock (Aluminum)

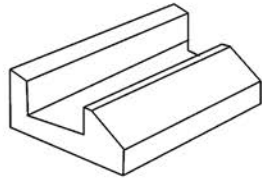

② Hook (Aluminum)



③ Aluminum Edge (Slopes)

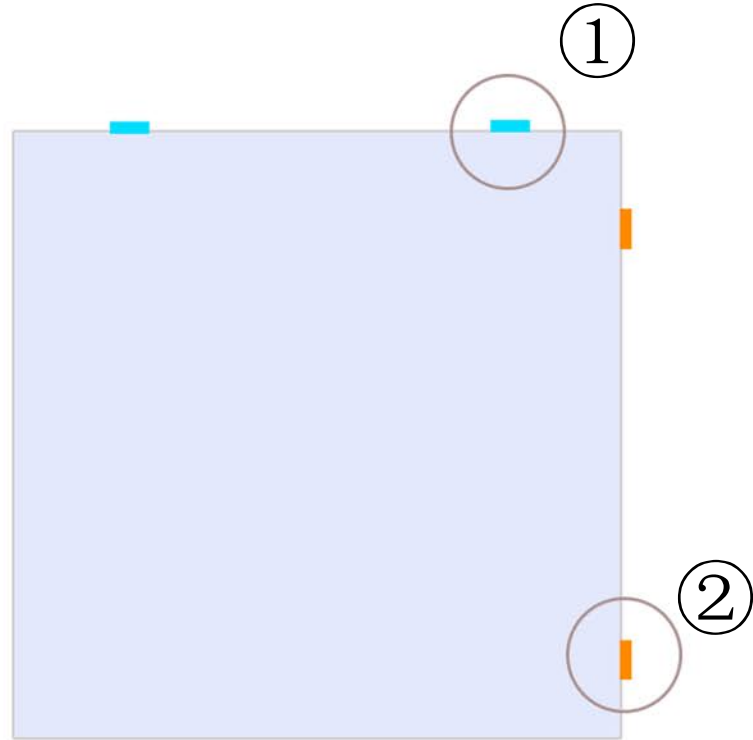

Top View

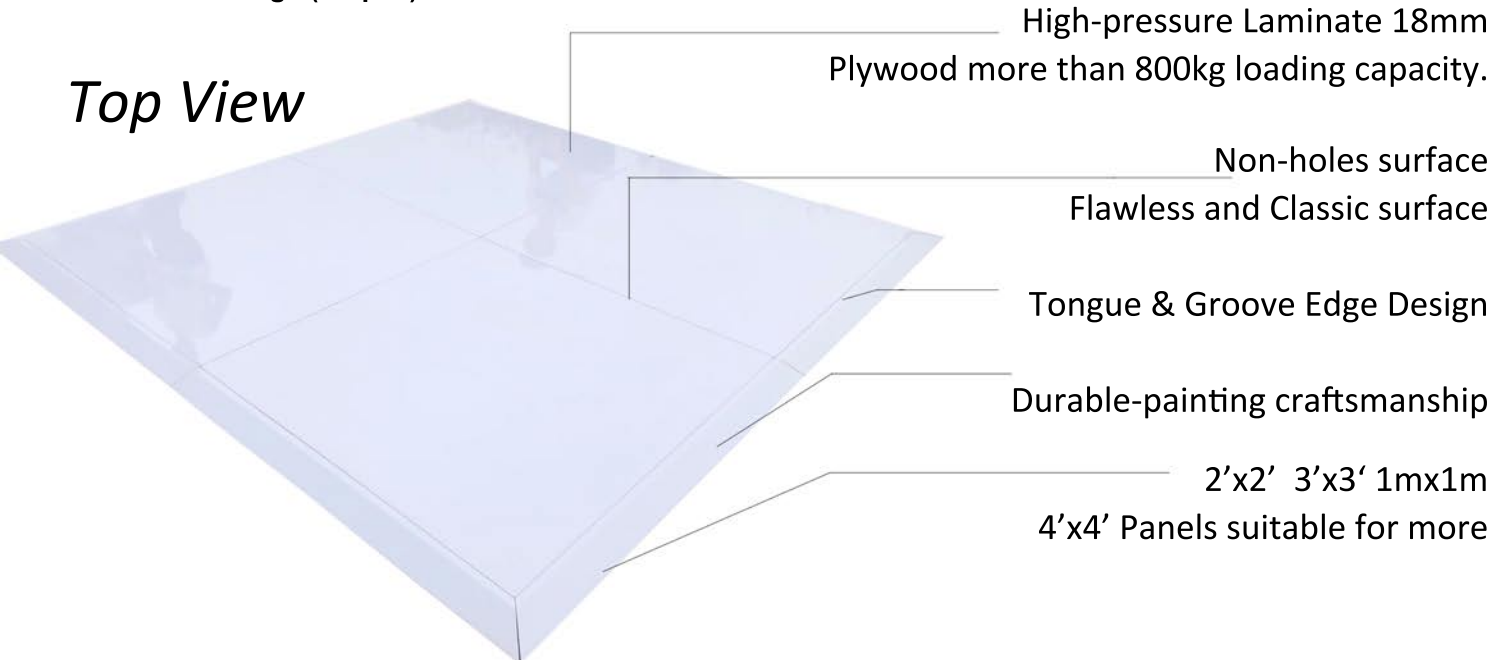

High-pressure Laminate 18mm
Plywood more than 800kg loading capacity.

Non-holes surface
Flawless and Classic surface

Tongue & Groove Edge Design

Durable-painting craftsmanship

2'x2' 3'x3' 1mx1m
4'x4' Panels suitable for more

Bottom View

Flat and smooth Bottom
No damages on ground tile / carpet

Waterproof & Sealed Underneath
Each Clean and longer lifespan

Color matching aluminum frame
"Seamless" Gorgeous design



Referring to party attenders number

Floor Size	Panels	Dancers	Caddies
8'x 8' (244cm x 244cm)	4	16	1
8'x12' (244cm x 366cm)	6	24	1
8'x16' (244cm x 488cm)	8	32	1
12'x16' (366cm x 488cm)	12	48	1
12'x20' (366cm x 610cm)	15	60	1
16'x16' (488cm x 488cm)	16	64	1
16'x20' (488cm x 610cm)	20	80	1
16'x24' (488cm x 732cm)	24	96	1
16'x28' (488cm x 853cm)	28	112	2
16'x32' (488cm x 975cm)	32	128	2
20'x20' (610cm x 610cm)	25	100	2
20'x24' (610cm x 732cm)	30	120	2

20'x28' (610cm x 853cm)	35	140	2
24'x24' (732cm x 732cm)	36	144	2
20'x32' (610cm x 975cm)	40	160	2
24'x28' (732cm x 853cm)	42	168	2
24'x32' (732cm x 975cm)	48	192	2
24'x36' (732cm x 1097cm)	54	216	3
28'x32' (853cm x 975cm)	56	224	3
32'x32' (975cm x 975cm)	64	256	3
32'x36' (975cm x 1097cm)	72	288	3
36'x36' (1097cm x 1097cm)	81	324	4
36'x40' (1097cm x 1219cm)	90	360	4
40'x40' (1219cm x 1219cm)	100	400	4

Assume that only one-third of your guests will dance, so the number of dancers shown in these graphs is only 33% of your total guests.

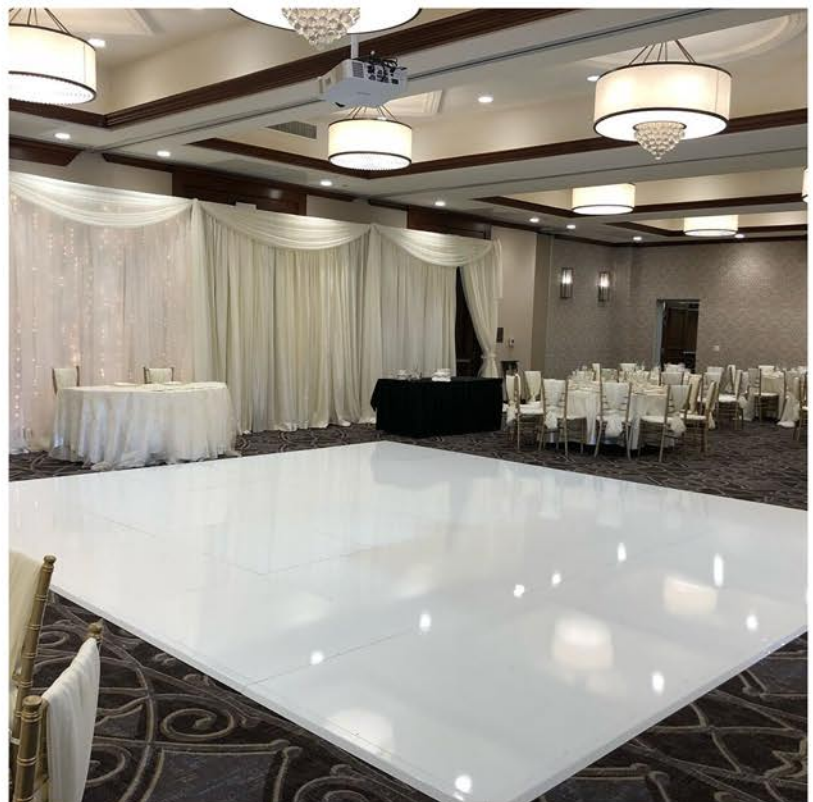

Customized Circular Designs 20' -24' -30' -32'



Wooden dance floor Diameter 20ft

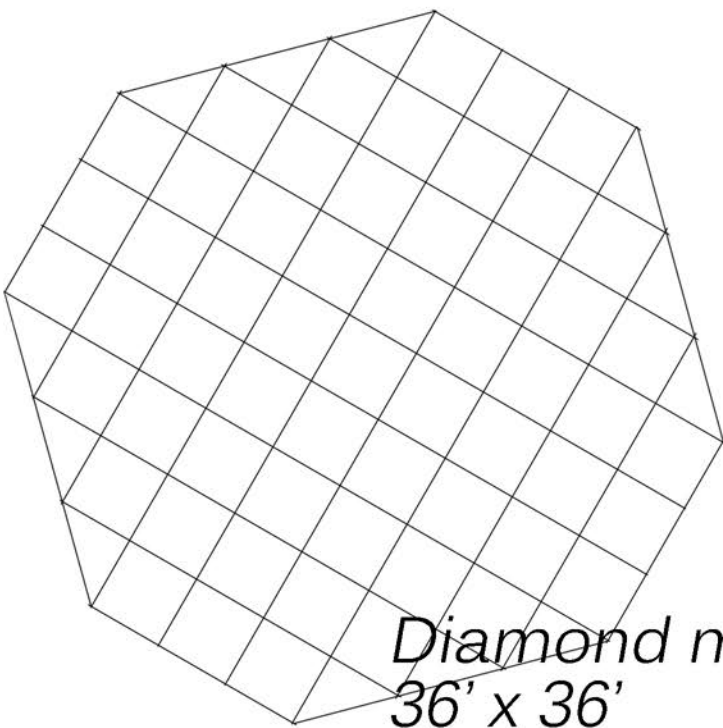
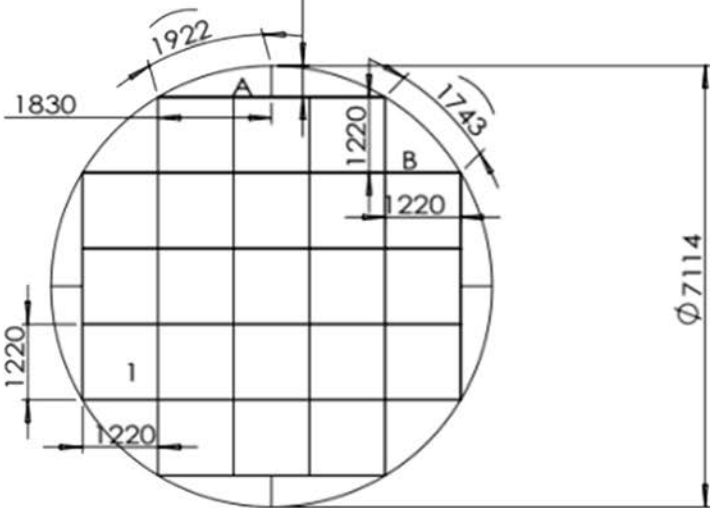
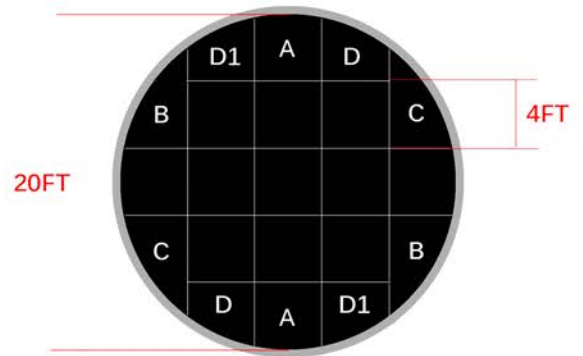

Diamond model
36' x 36'

Walkway
44' x 20'

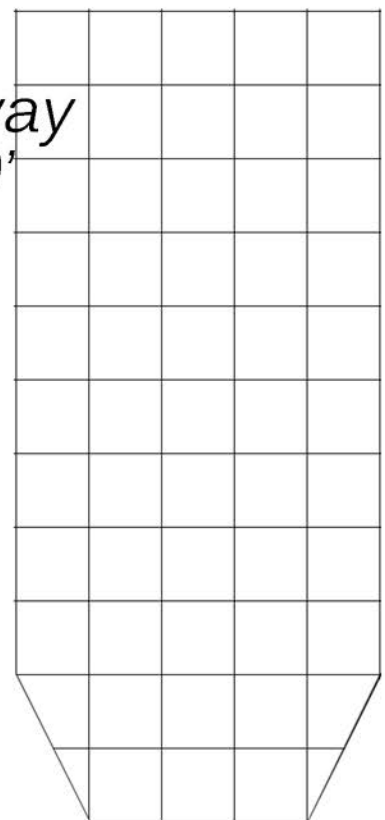

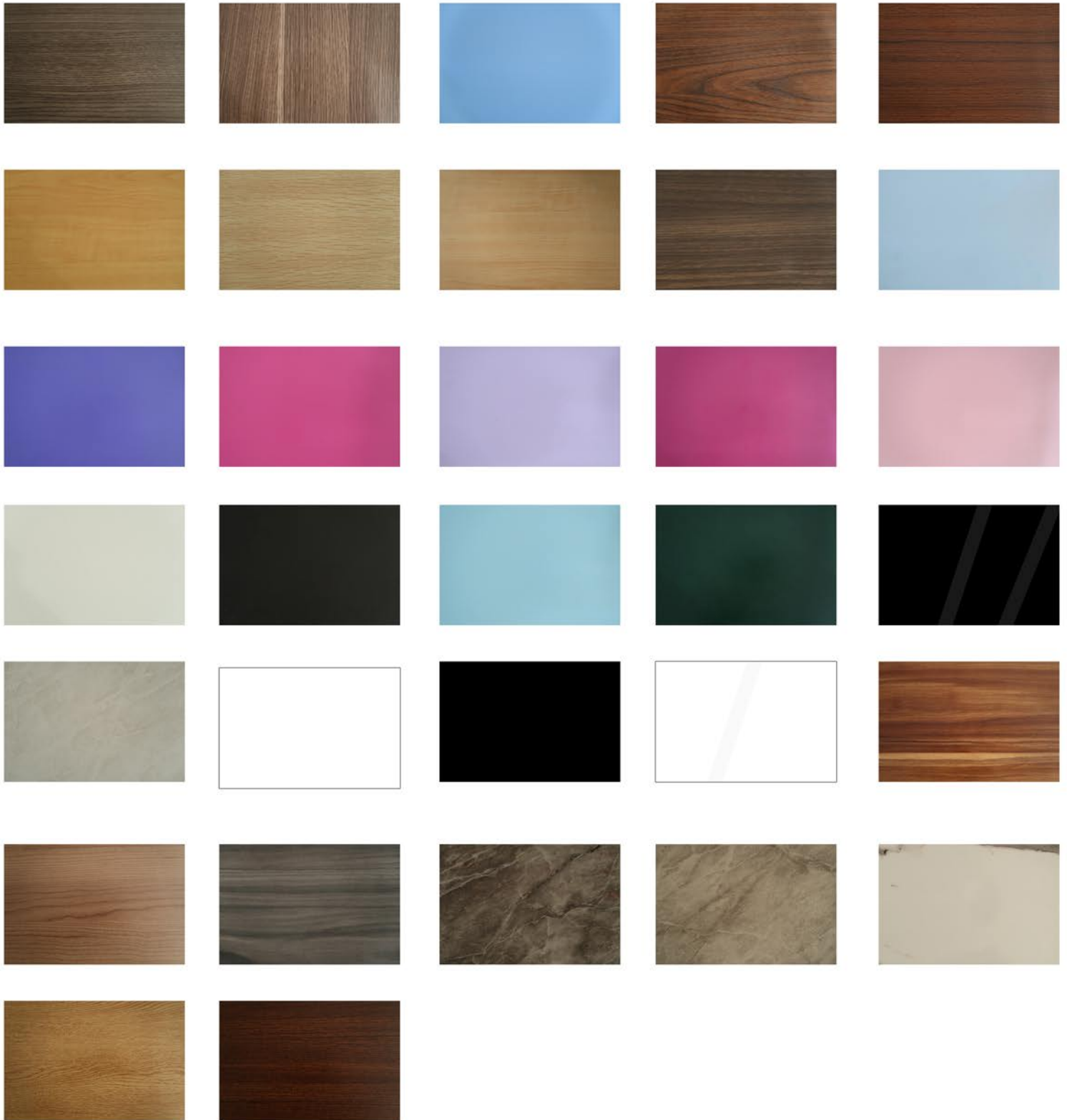

Visit our website for more new colors



Trolley

Walk-in design makes loading/unloading easy and safe. Securely holds 25 panels and trim.



Flight Case

Securely holds 8 panels and trim together. Logo can be customized paint on cases



Carton

Simple and economical package.

Want to Find More ?

Anycase Co.,Ltd.

Add: Building B, No. 79 Zhujiang Road ,Chaotian Industrial Park, Panyu District, Guangzhou, China

Contact: Van Ye

Tel: 0086-18028528679

Email: van@stageking.cn

